

NETVU ETHERNET-OVER-COAX ADAPTOR POWERED



Designed, manufactured and supported in the United Kingdom, with software written entirely to Western Standards, the NetVu Uniplex range provides the best solution for every application. The NetVu Ethernet-Over-Coax Adaptor allows the re-use of legacy coaxial cable infrastructure when installing Uniplex recorders and SmartVu IP cameras

WHY UNIPLEX?

- ✓ Compliance with the latest Secure by Design guidelines, offering complete immunity from cyber threats.
- ✓ Connect NetVu cameras over Co-axial or Ethernet cables, offering a lower cost to upgrade legacy analogue video surveillance systems to high definition IP.
- ✓ Automatic firewall and VLAN configuration for better cyber security.
- ✓ Simple configuration and maintenance with the option of Cloud-based support and configuration, further reducing installation and configuration costs.
- ✓ MultiMode™ recording with NetVu cameras reduces storage needs while maintaining very high recording quality, offering initial savings on storage costs and extended Hard Disk Drive life.
- ✓ Simple data capture, recording and presentation from EPOS, Electronic Access Control and Building Management Systems.

KEY FEATURES

- Transmits a single channel IP camera signal over existing coaxial cable.
- Designed to exceed the IEEE 802.3 10 BaseT specification.
- Transmission distance up to 800m Maximum at 10Mbps using RG59 coaxial cable.
- PoE supported. PoE powered.
- Transmission Rate/Bandwidth: 10/100 Mbps providing Half/Full Duplex Transmission.
- Built-in surge protection protects both cameras and Uniplex recorder inputs.
- Fast and easy to Install.
- Simple and low-cost conversion of analogue CCTV systems to HD IP video surveillance.

Technical Specifications	
Connections	1 x Ethernet (10/100 RJ 45 connections) 1 x BNC Male 75 Ohms
Network Standard	IEEE802.3 IEEE802.3u IEEE802.3x
Transmission Bandwidth	RG59 coaxial cable 400m/100Mbps. RG59 coaxial cable 1000m/10Mbps.
PoE Protocol	IEEE802.3af. IEEE802.3at
PoE Maximum Load	RG59 cable 100m – 21W RG59 cable 200m – 15W RG59 cable 300m – 11W RG59 cable 400m – 9W RG59 cable 500m – 7W RG59 cable 800m – 5W RG59 cable 1000m – 4W
Lightning Protection	Common Mode 4kV Differential Mode 2kV

Alarm Reporting	NetVu Connected Remote Alarm Reporting. SNMP Remote Alarm Reporting.
Network Protocols:	NetVu Connected Advanced Streaming, HTTP/HTTPS, TCP/IP, UDP/IP, RTSP/RTP Unicast and Multicast, Telnet / SSH, FTP, PoE, NTP, SNMP, Zeroconf, ModBus, iSCSI.
General Specification & Warranty	
Power	PoE 2W
Operating Temperature	-30°C to 65°C (-22°F to 149°F)
Operating Humidity	5% to 95% (Non-condensing).
Approvals	CE marked. Complies with part 15 of FCC CFR47. RoHS Compliant.
Weight	61g
Warranty	1 year

TECHNICAL DRAWING

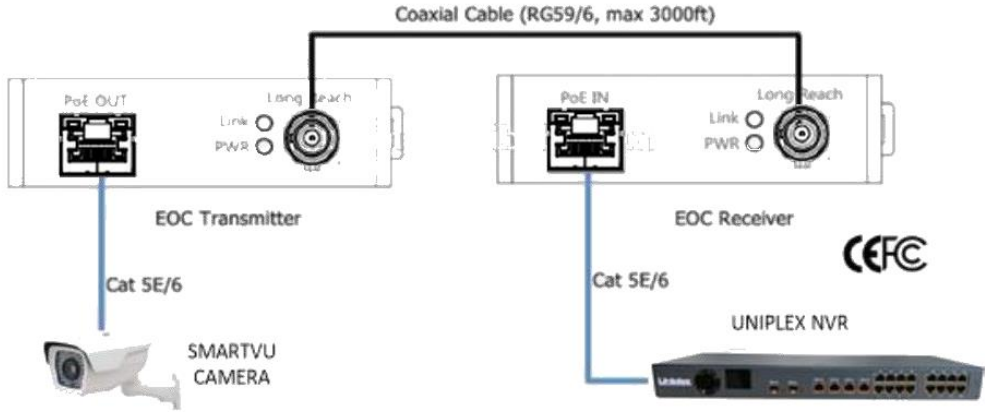

PART NUMBERING

Ethernet Over Coax Adaptor

EOCA/ACC2



ACCESSORIES

Uniplex Appliance	UPXA
Uniplex Desktop	UPXD
Uniplex Hybrid	UPXH

NETVU VIDEO MANAGEMENT SOFTWARE

NetVu Pick-a-Point	PPW03
NetVu Enterprise Observer	ENVO
NetVu Archive Management	AMS

Version 1.0 © Copyright NetVu Limited. 04/03/2020. Design and specification subject to change without notice. E. and O.E.